

PYRO PANEL LIFE SAFETY DOOR

Fire, Smoke and Acoustic Door with Lorient seals

DESCRIPTION

Up to 120 minute Fire Rated Pyropanel Life Safety Door which incorporates a choice of high performance Lorient Cold / Medium / Hot[#] smoke seals that has been tested for fire resistance, smoke leakage and acoustic performance.

APPLICATIONS

Ideal for apartment entry doors or other applications that require up to 120 minutes of fire resistance, smoke resistance and acoustic resistance.

FEATURES

- **SMOKE RESISTANCE (SRL): COLD / MEDIUM / HOT[#]**
- **FIRE RESISTANCE (FRL): Up to -/120/30**
- Smoke tested to AS1530.7
- Fire tested to AS1530.4
- Some acoustically tested (48mm nom. doors with packed steel frame).
- 48mm and 38mm thick, Single leaf assemblies.
- Variety of Medium and Hot temperature (intumescent) smoke sealing combinations available (see table over leaf).
- Quantifiable smoke leakage rates (as per AS 1530.7) for doors up to 2100 x 920mm. (Doors larger than 2100 x 920, smoke leakage rates have not been measured)
- FRL size limitation for Pyropanel Life Safety Doors is 2400 x 1020mm
- All door sizes (i.e up to 2400 x 1020mm) satisfy the requirements of NCC Specification C3.4 as a "Smoke Door".
- For large doors outside the above limitations, please contact Pyropanel to discuss options available.

INSTALLATION NOTES

- Gaps for fire doors in the closed position are not to exceed 3mm at vertical stiles and the head, between the door edge and frame.
- Bottom gaps for fire doors (between the leaf and top of finished floor level) are not to exceed 10mm.
- Refer to Lorient seal installation instructions (www.lorient.com.au), to ensure correct gaps are provided for seals also.
- Bottom seals to be used with a flat threshold (e.g Lorient LAS 4002si) to ensure the acoustic or smoke rating is not compromised.

[#] If Hot smoke protection is required, the Lorient LAS 1812 LSS perimeter seal and Lorient Hot smoke bottom seal (e.g LAS 8001HSS) can be used.

Steel door frame back filled as per **BUILD-01** tech-sheet.

Pyropanel LSD door leaf.

Lorient perimeter smoke seal LAS1212 (shown) or LAS1812LSS

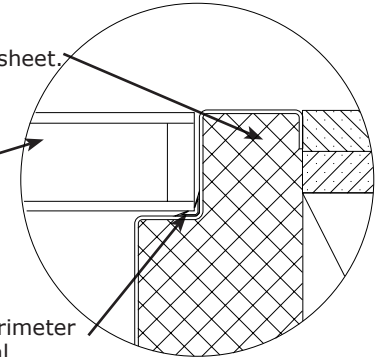

Lorient Bottom seal options

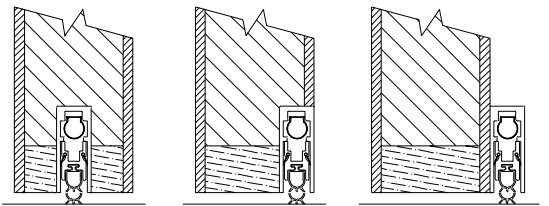

Fully morticed (FM)

Semi morticed (SM)

Surface Mounted (S)

LAS 8001si,
LAS 8005si.

LAS 8002si,
LAS 8003si.

LAS 8002si,
LAS 8003si,
LAS 8008si.

Note: All these bottom seals are available with an intumescent hot smoke seal (HSS) gasket (e.g LAS 8001HSS)

HOW TO SPECIFY

Determine the FRL required, the smoke resistance required, if an acoustic rating is required, and finally the seal combination desired.

Eg: "Doors to be a Pyropanel Life Safety Door LSD-60*-C/M/H* with steel door frame, 48mm nom.* thick, -/60*/30 FRL, with Lorient LAS 1812LSS* Hot smoke perimeter seal, and Lorient LAS 8001HSS* fully-morticed* bottom Hot smoke seal.

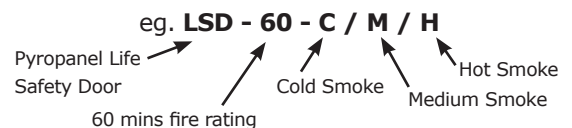

*Denotes example - delete, change or specify as required.

PYROPANEL LIFE SAFETY DOOR

Fire, Smoke and Acoustic Door with Lorient seals

LSD MODELS AND PERFORMANCE DATA

Model no	Perimeter seal	Bottom seal	AS1530.7 Medium temp (200°C) Smoke leakage (m ³ /h) corrected to STP for single leaf doorsets ¹				Acoustic rating Rw 48/38 (mm) nom. leaf thickness	Complies with the NCC ²	Complies with AS 6905.1 ³
			@10Pa		@25Pa				
			Test A at 30mins	Test B at 60mins	Test C at 30mins	Test D at 60mins			
LSD-30 with Cold & Medium smoke seals									
LSD-30-C/M	LAS1212	LAS8001si (FM) LAS8002si (SM/S) LAS8003si (SM/S) LAS8005si (FM) LAS8008si (S)	<2	5	2	11	30 / -	✓	✓
LSD-30 with Cold, Medium & Hot smoke seals									
LSD-30-C/M/H	LA1812LSS	HSS versions of above models, e.g LAS8001HSS	<2	5	2	11	30 / -	✓	✓
LSD-60 with Cold & Medium smoke seals									
LSD-60-C/M	LAS1212	LAS8001si (FM) LAS8002si (SM/S) LAS8003si (SM/S) LAS8005si (FM) LAS8008si (S)	<2	5	2	11	30 / -	✓	✓
LSD-60 with Cold, Medium & Hot smoke seals									
LSD-60-C/M/H	LA1812LSS	HSS versions of above models, e.g LAS8001HSS	<2	5	2	11	30 / -	✓	✓
LSD-120 with Cold & Medium smoke seals									
LSD-120-C/M	LAS1212	LAS8001si (FM) LAS8002si (S) LAS8003si (S) LAS8005si (FM) LAS8008si (S)	<2	5	2	11	30 / -	✓	✓
LSD-120 with Cold, Medium & Hot smoke seals									
LSD-120-C/M/H	LA1812LSS	HSS versions of above models, e.g LAS8001HSS	<2	5	2	11	30 / -	✓	✓

PERIMETER SEALS

LAS1212



LA1812 LSS

Bottom Seal Orientation: FM- Fully Morticed, SM- Semi Morticed, S- Surface Mounted
 Note 1: Leakage rates for 2100 x 920mm door.
 Note 2: NCC/BCA specification C3.4 clause 3.2(b).
 Note 3: Smoke leakage ≤25 m³/h for single leaf doors when exposed to 200°C at 25 Pa at 200°C for 30 minutes, corrected to STP, i.e test D in table above.

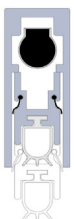
BOTTOM SEALS

LAS8001si^

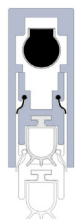

LAS8002si^

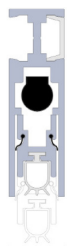

LAS8003si^

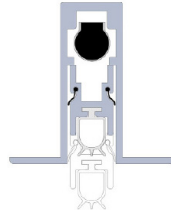

LAS8005si^



LAS8008si^

^ All these bottom seals are available with an intumescent Hot smoke seal(HSS) gasket (e.g LAS 8001HSS).

Pyropanel Developments Pty Ltd
 235 Huntingdale Rd, Oakleigh, Vic 3166
 Ph: (03) 9837 8500 Fax: (03) 9837 8550
 Email: sales@pyropanel.com.au
 Web: www.pyropanel.com.au

DISTRIBUTION:

SEALS BY:

